

\*親機のみ単体販売は行っていません。

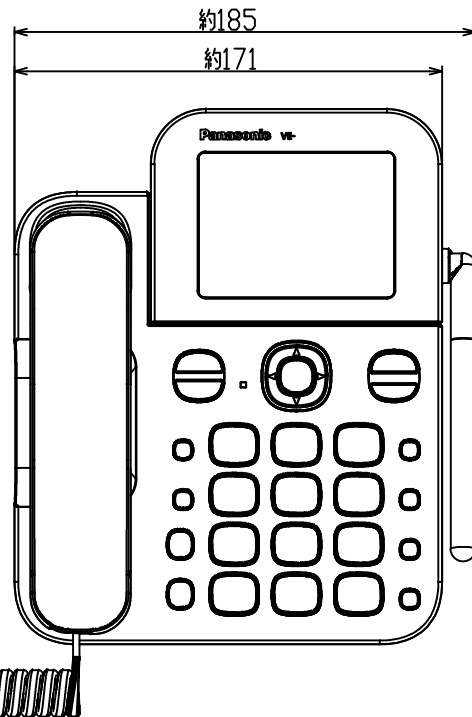
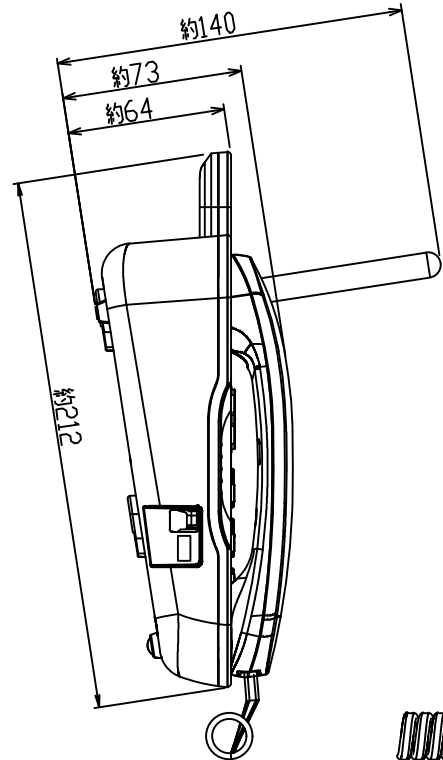
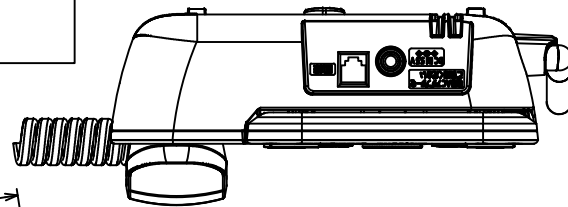

Panasonic

親機: VE-GD67.dxf

\*DLは子機1台のセット、DWは子機2台のセットになります。  
\*増設子機の別売品でご購入の際は、付属子機と同色の  
カラー展開がない場合があります。

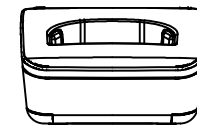
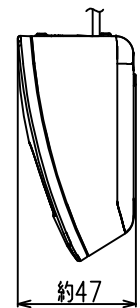
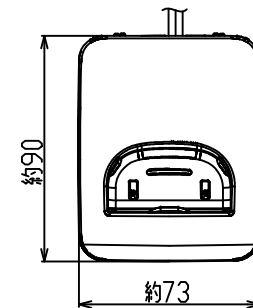
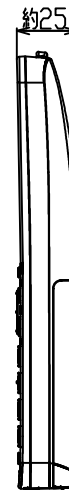
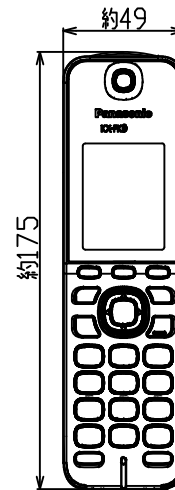

Panasonic

子機: KX-FKD556.dxf