

# 兼容功能列表

当本机与 AW-UE155 系列 4K 一体化摄像机结合使用时，本机的某些按钮、拨盘和其他控件的功能会受到限制或被禁用。请确保参阅下表。

## 注意

要执行操作，请将本机的系统版本升级到 4.00.01 或更高版本。

### 设置项目（专用拨盘和按钮）

#### 颜色调整部分

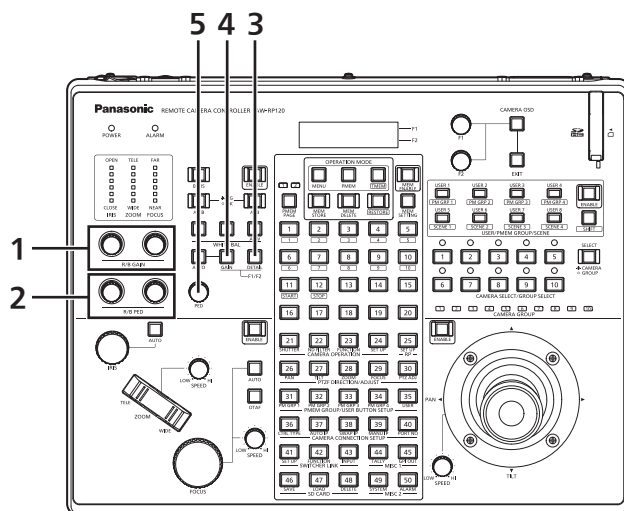

✓: 启用 ×: 禁用 △: 有条件地启用

编号	旋钮 / 按钮	兼容模式	备注
1	R/B GAIN	✓	
2	R/B PED	✓	
3	DETAIL	✓	
4	GAIN	✓	
5	PED	✓	

#### 菜单和存储器选择部分

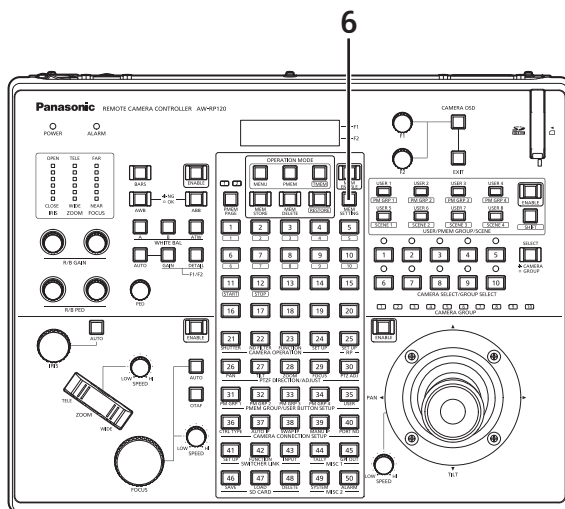

✓: 启用 ×: 禁用 △: 有条件地启用

编号	旋钮 / 按钮	兼容模式	备注
6	MEM SETTING	△	当远程摄像机的 [Preset Speed Unit] 为 “Time” 时，会显示 “---” 且无法设置。无法从本机执行时间规格。

设置项目 (菜单)

菜单和存储器选择部分

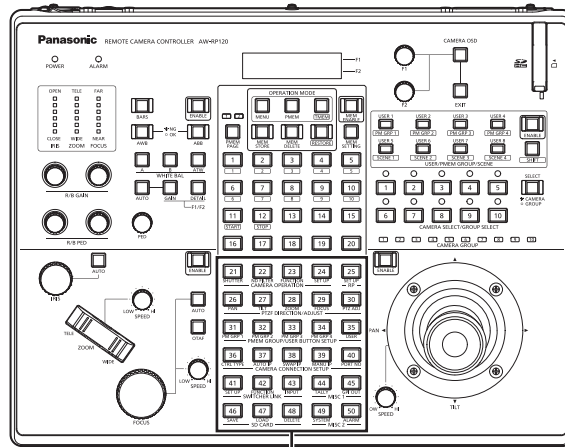

编号按钮 [21] 至 [50]

✓: 启用 ×: 禁用 △: 有条件地启用

编号按钮	菜单名称	设置项目	兼容模式	备注
[21]	SHUTTER	1.SHUTTER	✓	
		2.SPEED	✓	
[22]	ND FILTER	1.ND FILTER	✓	
[23]	FUNCTION	1.OPTION	✓	
		2.DEFROSTER	×	
		3.WIPER	×	
		4.HEATER/FAN	×	
		5.LAMP	×	
		6.PRESET SPEED	✓	
		7.FREEZE DURING	✓	
		8.I.S.	✓	
		9.D.EXTENDER	△	只能设置 ON 或 OFF。
		10.CROP OUT SEL	✓	
		11.CROP ADJ SEL	✓	
		12.CROP P/T LVR	✓	
		13.WASHR	×	
		14.FAN	✓	
		15.D.HAZE CLR SW	×	
		16.D.HAZE CLR LV	×	
		17.D-EXTENDER	✓	
		18.ZOOM MODE	✓	
		19.SHOOTING MD	✓	
		20.DRS	✓	
		21.REC	×	
[24]	CAMERA SETUP	1.CAM POWER	✓	
		2.AUTO ON	✓	
		3.RECALL PST SPD	✓	

✓: 启用 ×: 禁用 △: 有条件地启用

编号按钮	菜单名称	设置项目	兼容模式	备注
[24]	CAMERA SETUP	4.TALLY OUT	✓	
		5.COLOR TEMP	✓	
		6.HOME POSITION	✓	
		7.GAIN SW	✓	
		8.ATW SW	✓	
[25]	RP SETUP	1.FOUCS/IRIS	✓	
		2.P/T CURV	✓	
		3.LCD BACKLIGHT	✓	
		4.ENABLE BUTTON	✓	
		5.MENU CONTROL	✓	
		6.GLOBAL AREA	✓	
		7.IP ADDRESS	✓	
		8.SUBNET MASK	✓	
		9.GATEWAY	✓	
		10.MAC ADDRESS	✓	
		11.PORT CAM1 :	✓	
		20.PORT CAM10		
		21.PANEL LOCK PW	✓	
		22.PANEL LOCK CNT	✓	
		23.TR CTRL	✓	
24.TR IP ADDRESS	✓			
25.TR PORT	✓			
[26]	PAN DIRECTION	1.CAM1 : 100.CAM100	✓	
[27]	TILT DIRECTION	1.CAM1 : 100.CAM100	✓	
[28]	ZOOM DIRECTION	1.CAM1 : 100.CAM100	✓	
[29]	FOCUS DIRECTION	1.CAM1 : 100.CAM100	✓	
[30]	PTZ ADJUST	1.Z MIN SPEED	✓	
		2.SPEED WITH Z	✓	
		3.LIMIT UP	✓	
		4.LIMIT DOWN	✓	
		5.LIMIT LEFT	✓	
		6.LIMIT RIGHT	✓	
		7.AWB/ABB & P/T	✓	
[31]	PM GRP1	1.PM GRP1 MODE	✓	
		2.PM GRP1 1/10 :	✓	
		11.PM GRP1 10/10		
		12.PM GRP1 ALL	✓	

√: 启用 ×: 禁用 △: 有条件地启用

编号按钮	菜单名称	设置项目	兼容模式	备注
[32]	PM GRP2	1.PM GRP2 MODE	√	
		2.PM GRP2 1/10 :	√	
		11.PM GRP2 10/10		
		12.PM GRP2 ALL	√	
[33]	PM GRP3	1.PM GRP3 MODE	√	
		2.PM GRP3 1/10 :	√	
		11.PM GRP2 10/10		
		12.PM GRP3 ALL	√	
[34]	PM GRP4	1.PM GRP4 MODE	√	
		2.PM GRP4 1/10 :	√	
		11.PM GRP4 10/10		
		12.PM GRP4 ALL	√	
[35]	USER BUTTON	1.USER1 : 8.USER8	√	([FAN] 设置) 可以在“Auto”和“High”之间切换。
[36]	CTRL TYPE	1.CAM1 : 100.CAM100	√	
[37]	AUTO IP	1.AUTO SET	√	
[38]	SWAP IP	1.CAM1 : 100.CAM100	√	
[39]	MANU IP	1.CAM1 : 100.CAM100	√	
[40]	PORT NO	1.CAM1 : 100.CAM100	√	
[41]	SW SETUP	1.SW CTL	√	
		2.SW IP ADDRESS	√	
[42]	SW FUNCTION	1.SW LINK	√	
		2.SW TYPE	√	
		3.BUSCONT	√	
		4.BUS	√	
		5.FOUCS ASIST	√	
		6.MV OUTBUS	√	
		7.CAMERA SELECT	√	
		8.TALLY_IP	√	
		9.P/T/Z CONTROL	√	
		10.CAMINF	√	
		11.CAMINF_FORMAT	√	
		12.CAMINF_CNAME	√	
		13.CAMINF_SCENE	√	
		14.CAMINF_GAIN	√	
		15.CAMINF_SHUTER	√	
		16.CAMINF_IRIS	√	

√: 启用 ×: 禁用 △: 有条件地启用

编号按钮	菜单名称	设置项目	兼容模式	备注
[42]	SW FUNCTION	17.CAMINF_FILTER	√	
		18.CAMINF_ALARM	√	
[43]	SW INPUT	1.INPUT1 : 100.INPUT100	√	
[44]	TALLY	1.TALLY IN1 : 10.TALLY IN10	√	
[45]	GPI OUT	1.CAM OUT1 : 10.CAM OUT10	√	
[46]	SAVE	SAVE MODE	√	
[47]	LOAD	LOAD MODE	√	
[48]	DELETE	DEL MODE	√	
[49]	SYSTEM	1.INITIALIZE	√	
		2.SYSTEM VER	√	
		3.PROGRAM VER	√	
		4.FPGA VER	√	
[50]	ALARM	1.POWER	√	
		2.CAM*** : 11.CAM***	√	“***” 是选定组的摄像机编号。

# Compatible Functions List

When the unit is used in conjunction with an AW-UE150 Series 4K Integrated Camera, there will be functions that are limited or disabled for some of the unit's buttons, dials, and other controls. Be sure to refer to the following table.

**NOTE**

To perform operations, upgrade the system version of the unit to 4.00.01 or later.

**Setting items (dedicated dials and buttons)**

**Color adjustment section**

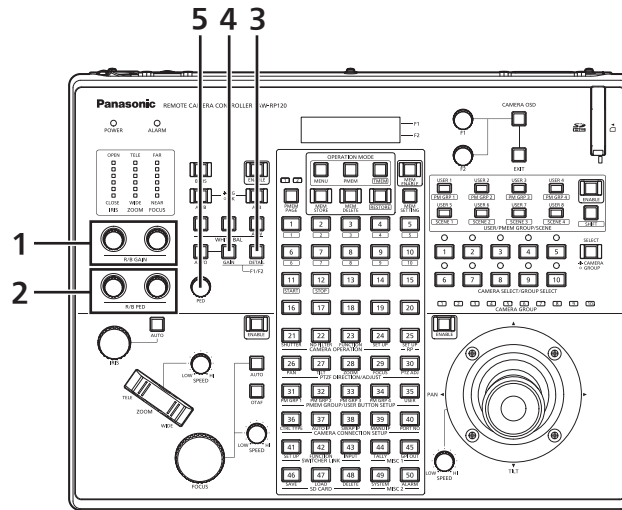

✓: Enabled X: Disabled △: Enabled conditionally

Number	Dial/button	Compatible	Remarks
1	R/B GAIN	✓	
2	R/B PED	✓	
3	DETAIL	✓	
4	GAIN	✓	
5	PED	✓	

**Menu and memory selection section**

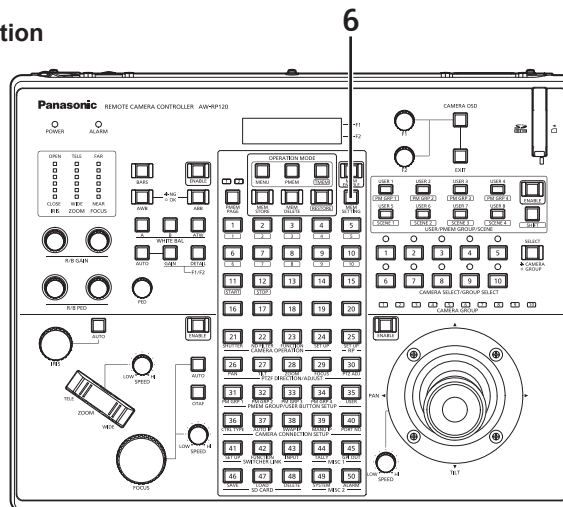

✓: Enabled X: Disabled △: Enabled conditionally

Number	Dial/button	Compatible	Remarks
6	MEM SETTING	△	When [Preset Speed Unit] of the remote camera is "Time", "---" is displayed and setting is not possible. Time specification cannot be performed from the unit.

Setting items (menus)

Menu and memory selection section

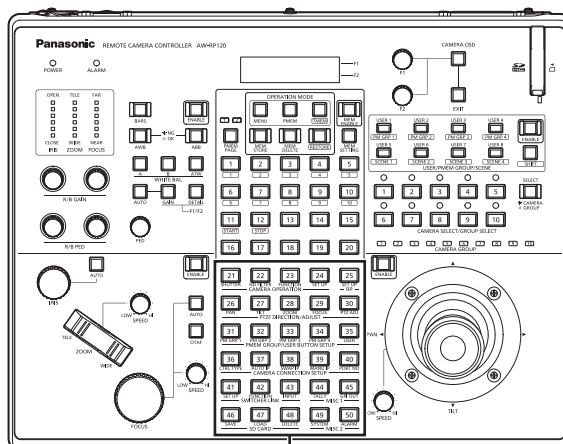

Number buttons [21] to [50]

✓: Enabled ×: Disabled △: Enabled conditionally

Number button	Menu name	Setting item	Compatible	Remarks
[21]	SHUTTER	1.SHUTTER	✓	
		2.SPEED	✓	
[22]	ND FILTER	1.ND FILTER	✓	
[23]	FUNCTION	1.OPTION	✓	
		2.DEFROSTER	×	
		3.WIPER	×	
		4.HEATER/FAN	×	
		5.LAMP	×	
		6.PRESET SPEED	✓	
		7.FREEZE DURING	✓	
		8.I.S.	✓	
		9.D.EXTENDER	△	Only ON or OFF can be set.
		10.CROP OUT SEL	✓	
		11.CROP ADJ SEL	✓	
		12.CROP P/T LVR	✓	
		13.WASHR	×	
		14.FAN	✓	
		15.D.HAZE CLR SW	×	
		16.D.HAZE CLR LV	×	
		17.D-EXTENDER	✓	
		18.ZOOM MODE	✓	
		19.SHOOTING MD	✓	
		20.DRS	✓	
		21.REC	×	
[24]	CAMERA SETUP	1.CAM POWER	✓	
		2.AUTO ON	✓	
		3.RECALL PST SPD	✓	

✓: Enabled ✕: Disabled △: Enabled conditionally

Number button	Menu name	Setting item	Compatible	Remarks
[24]	CAMERA SETUP	4.TALLY OUT	✓	
		5.COLOR TEMP	✓	
		6.HOME POSITION	✓	
		7.GAIN SW	✓	
		8.ATW SW	✓	
[25]	RP SETUP	1.FOUCS/IRIS	✓	
		2.P/T CURV	✓	
		3.LCD BACKLIGHT	✓	
		4.ENABLE BUTTON	✓	
		5.MENU CONTROL	✓	
		6.GLOBAL AREA	✓	
		7.IP ADDRESS	✓	
		8.SUBNET MASK	✓	
		9.GATEWAY	✓	
		10.MAC ADDRESS	✓	
		11.PORT CAM1 :	✓	
		20.PORT CAM10		
		21.PANEL LOCK PW	✓	
		22.PANEL LOCK CNT	✓	
		23.TR CTRL	✓	
24.TR IP ADDRESS	✓			
25.TR PORT	✓			
[26]	PAN DIRECTION	1.CAM1 : 100.CAM100	✓	
[27]	TILT DIRECTION	1.CAM1 : 100.CAM100	✓	
[28]	ZOOM DIRECTION	1.CAM1 : 100.CAM100	✓	
[29]	FOCUS DIRECTION	1.CAM1 : 100.CAM100	✓	
[30]	PTZ ADJUST	1.Z MIN SPEED	✓	
		2.SPEED WITH Z	✓	
		3.LIMIT UP	✓	
		4.LIMIT DOWN	✓	
		5.LIMIT LEFT	✓	
		6.LIMIT RIGHT	✓	
		7.AWB/ABB & P/T	✓	
[31]	PM GRP1	1.PM GRP1 MODE	✓	
		2.PM GRP1 1/10 :	✓	
		11.PM GRP1 10/10		
		12.PM GRP1 ALL	✓	



✓: Enabled ✕: Disabled △: Enabled conditionally

Number button	Menu name	Setting item	Compatible	Remarks
[32]	PM GRP2	1.PM GRP2 MODE	✓	
		2.PM GRP2 1/10 ⋮ 11.PM GRP2 10/10	✓	
		12.PM GRP2 ALL	✓	
[33]	PM GRP3	1.PM GRP3 MODE	✓	
		2.PM GRP3 1/10 ⋮ 11.PM GRP3 10/10	✓	
		12.PM GRP3 ALL	✓	
[34]	PM GRP4	1.PM GRP4 MODE	✓	
		2.PM GRP4 1/10 ⋮ 11.PM GRP4 10/10	✓	
		12.PM GRP4 ALL	✓	
[35]	USER BUTTON	1.USER1 ⋮ 8.USER8	✓	<b>([FAN] setting)</b> Can be switched between "Auto" and "High".
[36]	CTRL TYPE	1.CAM1 ⋮ 100.CAM100	✓	
[37]	AUTO IP	1.AUTO SET	✓	
[38]	SWAP IP	1.CAM1 ⋮ 100.CAM100	✓	
[39]	MANU IP	1.CAM1 ⋮ 100.CAM100	✓	
[40]	PORT NO	1.CAM1 ⋮ 100.CAM100	✓	
[41]	SW SETUP	1.SW CTL	✓	
		2.SW IP ADDRESS	✓	
[42]	SW FUNCTION	1.SW LINK	✓	
		2.SW TYPE	✓	
		3.BUSCONT	✓	
		4.BUS	✓	
		5.FOUCS ASIST	✓	
		6.MV OUTBUS	✓	
		7.CAMERA SELECT	✓	
		8.TALLY_IP	✓	
		9.P/T/Z CONTROL	✓	
		10.CAMINF	✓	
		11.CAMINF_FORMAT	✓	
		12.CAMINF_CNAME	✓	
		13.CAMINF_SCENE	✓	
		14.CAMINF_GAIN	✓	
		15.CAMINF_SHUTER	✓	
		16.CAMINF_IRIS	✓	

✓: Enabled ✕: Disabled △: Enabled conditionally

Number button	Menu name	Setting item	Compatible	Remarks
[42]	SW FUNCTION	17.CAMINF_FILTER	✓	
		18.CAMINF_ALARM	✓	
[43]	SW INPUT	1.INPUT1 : 100.INPUT100	✓	
[44]	TALLY	1.TALLY IN1 : 10.TALLY IN10	✓	
[45]	GPI OUT	1.CAM OUT1 : 10.CAM OUT10	✓	
[46]	SAVE	SAVE MODE	✓	
[47]	LOAD	LOAD MODE	✓	
[48]	DELETE	DEL MODE	✓	
[49]	SYSTEM	1.INITIALIZE	✓	
		2.SYSTEM VER	✓	
		3.PROGRAM VER	✓	
		4.FPGA VER	✓	
[50]	ALARM	1.POWER	✓	
		2.CAM*** : 11.CAM***	✓	“***” is the camera number of the selected group.

# Liste der kompatiblen Funktionen

Wird das Gerät in Verbindung mit einer 4K Remote Kamera der Serie AW-UE150 verwendet, werden Funktionen für gewisse Tasten, Knöpfe und andere Steuerfunktionen des Geräts begrenzt oder deaktiviert. Beziehen Sie sich auf folgende Tabelle.

**HINWEIS**

Zum Ausführen von Vorgängen aktualisieren Sie die Systemversion der Einheit auf 4.00.01 oder höher.

**Einstellungspunkte (Dedizierte Knöpfe und Tasten)**

**Bereich für die Farbanpassung**

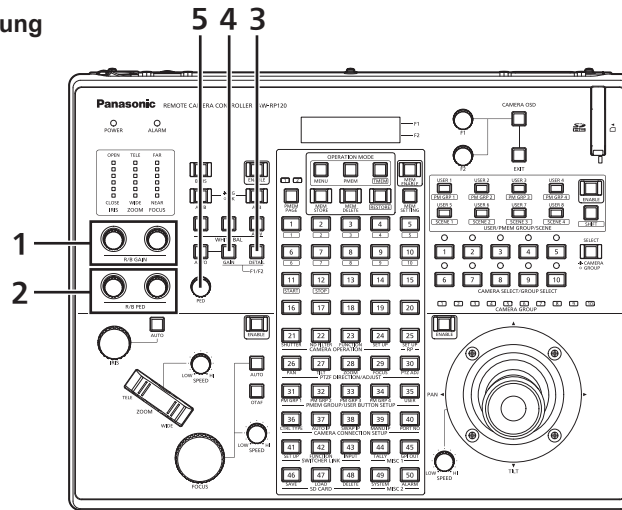

✓: Aktiviert ×: Deaktiviert △: Bedingt aktiviert

Nummer	Knopf/Taste	Kompatibel	Anmerkungen
1	R/B GAIN	✓	
2	R/B PED	✓	
3	DETAIL	✓	
4	GAIN	✓	
5	PED	✓	

**Bereich für Menü- und Speicherauswahl**

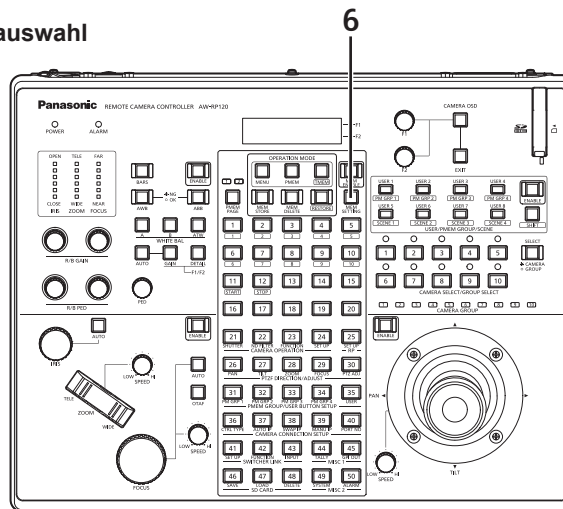

✓: Aktiviert ×: Deaktiviert △: Bedingt aktiviert

Nummer	Knopf/Taste	Kompatibel	Anmerkungen
6	MEM SETTING	△	Wenn [Preset Speed Unit] der Netzwerkkamera auf "Time" gestellt ist, wird "---" angezeigt und die Einstellung ist nicht möglich. Die Zeitspezifikation kann nicht vom Gerät aus durchgeführt werden.

Einstellungspunkte (Menüs)

Bereich für Menü- und Speicherauswahl

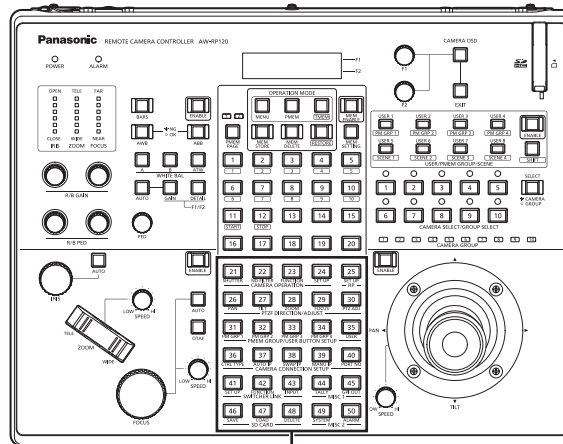

Nummerntasten von [21] bis [50]

✓: Aktiviert ×: Deaktiviert △: Bedingt aktiviert

Nummerntaste	Menüname	Einstellungspunkt	Kompatibel	Anmerkungen
[21]	SHUTTER	1.SHUTTER	✓	
		2.SPEED	✓	
[22]	ND FILTER	1.ND FILTER	✓	
[23]	FUNCTION	1.OPTION	✓	
		2.DEFROSTER	×	
		3.WIPER	×	
		4.HEATER/FAN	×	
		5.LAMP	×	
		6.PRESET SPEED	✓	
		7.FREEZE DURING	✓	
		8.I.S.	✓	
		9.D.EXTENDER	△	Es kann nur ON oder OFF eingestellt werden.
		10.CROP OUT SEL	✓	
		11.CROP ADJ SEL	✓	
		12.CROP P/T LVR	✓	
		13.WASHR	×	
		14.FAN	✓	
		15.D.HAZE CLR SW	×	
		16.D.HAZE CLR LV	×	
		17.D-EXTENDER	✓	
		18.ZOOM MODE	✓	
		19.SHOOTING MD	✓	
		20.DRS	✓	
		21.REC	×	
[24]	CAMERA SETUP	1.CAM POWER	✓	
		2.AUTO ON	✓	
		3.RECALL PST SPD	✓	

✓: Aktiviert ×: Deaktiviert △: Bedingt aktiviert

Nummerntaste	Menüname	Einstellungspunkt	Kompatibel	Anmerkungen
[24]	CAMERA SETUP	4.TALLY OUT	✓	
		5.COLOR TEMP	✓	
		6.HOME POSITION	✓	
		7.GAIN SW	✓	
		8.ATW SW	✓	
[25]	RP SETUP	1.FOUCS/IRIS	✓	
		2.P/T CURV	✓	
		3.LCD BACKLIGHT	✓	
		4.ENABLE BUTTON	✓	
		5.MENU CONTROL	✓	
		6.GLOBAL AREA	✓	
		7.IP ADDRESS	✓	
		8.SUBNET MASK	✓	
		9.GATEWAY	✓	
		10.MAC ADDRESS	✓	
		11.PORT CAM1 :	✓	
		20.PORT CAM10		
		21.PANEL LOCK PW	✓	
		22.PANEL LOCK CNT	✓	
		23.TR CTRL	✓	
24.TR IP ADDRESS	✓			
25.TR PORT	✓			
[26]	PAN DIRECTION	1.CAM1 : 100.CAM100	✓	
[27]	TILT DIRECTION	1.CAM1 : 100.CAM100	✓	
[28]	ZOOM DIRECTION	1.CAM1 : 100.CAM100	✓	
[29]	FOCUS DIRECTION	1.CAM1 : 100.CAM100	✓	
[30]	PTZ ADJUST	1.Z MIN SPEED	✓	
		2.SPEED WITH Z	✓	
		3.LIMIT UP	✓	
		4.LIMIT DOWN	✓	
		5.LIMIT LEFT	✓	
		6.LIMIT RIGHT	✓	
		7.AWB/ABB & P/T	✓	
[31]	PM GRP1	1.PM GRP1 MODE	✓	
		2.PM GRP1 1/10 :	✓	
		11.PM GRP1 10/10		
		12.PM GRP1 ALL	✓	

✓: Aktiviert ✗: Deaktiviert △: Bedingt aktiviert

Nummertaste	Menüname	Einstellungspunkt	Kompatibel	Anmerkungen
[32]	PM GRP2	1.PM GRP2 MODE	✓	
		2.PM GRP2 1/10 :	✓	
		11.PM GRP2 10/10		
		12.PM GRP2 ALL	✓	
[33]	PM GRP3	1.PM GRP3 MODE	✓	
		2.PM GRP3 1/10 :	✓	
		11.PM GRP3 10/10		
		12.PM GRP3 ALL	✓	
[34]	PM GRP4	1.PM GRP4 MODE	✓	
		2.PM GRP4 1/10 :	✓	
		11.PM GRP4 10/10		
		12.PM GRP4 ALL	✓	
[35]	USER BUTTON	1.USER1 : 8.USER8	✓	<b>([FAN]-Einstellung)</b> Kann zwischen "Auto" und "High" umgeschaltet werden.
[36]	CTRL TYPE	1.CAM1 : 100.CAM100	✓	
[37]	AUTO IP	1.AUTO SET	✓	
[38]	SWAP IP	1.CAM1 : 100.CAM100	✓	
[39]	MANU IP	1.CAM1 : 100.CAM100	✓	
[40]	PORT NO	1.CAM1 : 100.CAM100	✓	
[41]	SW SETUP	1.SW CTL	✓	
		2.SW IP ADDRESS	✓	
[42]	SW FUNCTION	1.SW LINK	✓	
		2.SW TYPE	✓	
		3.BUSCONT	✓	
		4.BUS	✓	
		5.FOUCS ASIST	✓	
		6.MV OUTBUS	✓	
		7.CAMERA SELECT	✓	
		8.TALLY_IP	✓	
		9.P/T/Z CONTROL	✓	
		10.CAMINF	✓	
		11.CAMINF_FORMAT	✓	
		12.CAMINF_CNAME	✓	
		13.CAMINF_SCENE	✓	
		14.CAMINF_GAIN	✓	
		15.CAMINF_SHUTER	✓	
		16.CAMINF_IRIS	✓	

✓: Aktiviert ✗: Deaktiviert △: Bedingt aktiviert

Nummertaste	Menüname	Einstellungspunkt	Kompatibel	Anmerkungen
[42]	SW FUNCTION	17.CAMINF_FILTER	✓	
		18.CAMINF_ALARM	✓	
[43]	SW INPUT	1.INPUT1 : 100.INPUT100	✓	
[44]	TALLY	1.TALLY IN1 : 10.TALLY IN10	✓	
[45]	GPI OUT	1.CAM OUT1 : 10.CAM OUT10	✓	
[46]	SAVE	SAVE MODE	✓	
[47]	LOAD	LOAD MODE	✓	
[48]	DELETE	DEL MODE	✓	
[49]	SYSTEM	1.INITIALIZE	✓	
		2.SYSTEM VER	✓	
		3.PROGRAM VER	✓	
		4.FPGA VER	✓	
[50]	ALARM	1.POWER	✓	
		2.CAM*** : 11.CAM***	✓	“***” ist die Kameranummer der ausgewählten Gruppe.

# Liste des fonctions compatibles

Lorsque l'appareil est utilisé en association avec une caméra robotisée 4K série AW-UE150, il y aura des fonctions qui seront limitées ou désactivées pour certains boutons, cadrans et autres commandes de l'appareil. S'assurer de vérifier les informations dans le tableau suivant.

## Remarque

Pour l'utilisation, mettre à niveau la version système de l'appareil à la version 4.00.01 ou ultérieure.

### Éléments de réglage (cadrans et boutons dédiés)

#### Section de réglage de couleur

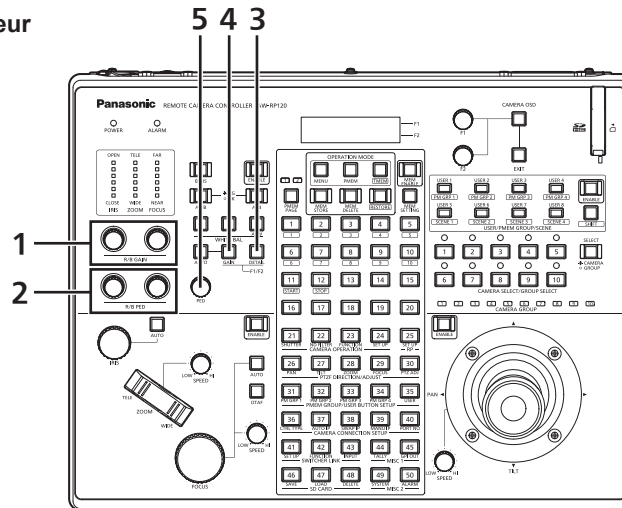

✓ : Activé × : Désactivé △ : Activé sous conditions

Numéro	Cadran/bouton	Compatible	Remarques
1	R/B GAIN	✓	
2	R/B PED	✓	
3	DETAIL	✓	
4	GAIN	✓	
5	PED	✓	

#### Section de sélection de menu et de mémoire

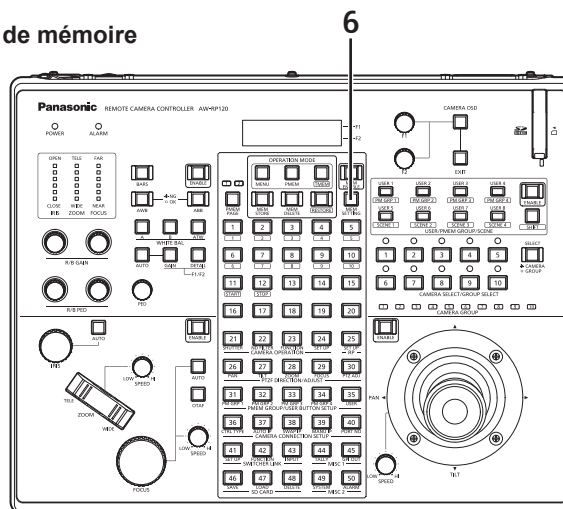

✓ : Activé × : Désactivé △ : Activé sous conditions

Numéro	Cadran/bouton	Compatible	Remarques
6	MEM SETTING	△	Lorsque [Preset Speed Unit] de la caméra distante est sur "Time", "---" s'affiche et le réglage n'est pas possible. La spécification du temps ne peut pas être effectuée à partir de l'appareil.



Éléments de réglage (menus)

Section de sélection de menu et de mémoire

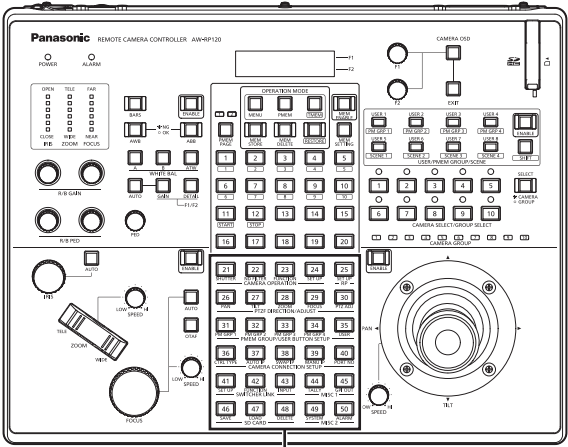

Boutons de numéros de [21] à [50]

✓: Activé ×: Désactivé △: Activé sous conditions

Bouton de numéro	Nom de menu	Élément de réglage	Compatible	Remarques
[21]	SHUTTER	1.SHUTTER	✓	
		2.SPEED	✓	
[22]	ND FILTER	1.ND FILTER	✓	
[23]	FUNCTION	1.OPTION	✓	
		2.DEFROSTER	×	
		3.WIPER	×	
		4.HEATER/FAN	×	
		5.LAMP	×	
		6.PRESET SPEED	✓	
		7.FREEZE DURING	✓	
		8.I.S.	✓	
		9.D.EXTENDER	△	Seuls ON ou OFF peuvent être réglés.
		10.CROP OUT SEL	✓	
		11.CROP ADJ SEL	✓	
		12.CROP P/T LVR	✓	
		13.WASHR	×	
		14.FAN	✓	
		15.D.HAZE CLR SW	×	
		16.D.HAZE CLR LV	×	
		17.D-EXTENDER	✓	
		18.ZOOM MODE	✓	
		19.SHOOTING MD	✓	
		20.DRS	✓	
		21.REC	×	

✓: Activé ×: Désactivé △: Activé sous conditions

Bouton de numéro	Nom de menu	Élément de réglage	Compatible	Remarques
[24]	CAMERA SETUP	1.CAM POWER	✓	
		2.AUTO ON	✓	
		3.RECALL PST SPD	✓	
		4.TALLY OUT	✓	
		5.COLOR TEMP	✓	
		6.HOME POSITION	✓	
		7.GAIN SW	✓	
		8.ATW SW	✓	
[25]	RP SETUP	1.FOUCS/IRIS	✓	
		2.P/T CURV	✓	
		3.LCD BACKLIGHT	✓	
		4.ENABLE BUTTON	✓	
		5.MENU CONTROL	✓	
		6.GLOBAL AREA	✓	
		7.IP ADDRESS	✓	
		8.SUBNET MASK	✓	
		9.GATEWAY	✓	
		10.MAC ADDRESS	✓	
		11.PORT CAM1 :	✓	
		20.PORT CAM10		
		21.PANEL LOCK PW	✓	
		22.PANEL LOCK CNT	✓	
		23.TR CTRL	✓	
24.TR IP ADDRESS	✓			
25.TR PORT	✓			
[26]	PAN DIRECTION	1.CAM1 : 100.CAM100	✓	
[27]	TILT DIRECTION	1.CAM1 : 100.CAM100	✓	
[28]	ZOOM DIRECTION	1.CAM1 : 100.CAM100	✓	
[29]	FOCUS DIRECTION	1.CAM1 : 100.CAM100	✓	
[30]	PTZ ADJUST	1.Z MIN SPEED	✓	
		2.SPEED WITH Z	✓	
		3.LIMIT UP	✓	
		4.LIMIT DOWN	✓	
		5.LIMIT LEFT	✓	
		6.LIMIT RIGHT	✓	
		7.AWB/ABB & P/T	✓	

✓: Activé ×: Désactivé △: Activé sous conditions

Bouton de numéro	Nom de menu	Élément de réglage	Compatible	Remarques
[31]	PM GRP1	1.PM GRP1 MODE	✓	
		2.PM GRP1 1/10	✓	
		⋮		
		11.PM GRP1 10/10		
		12.PM GRP1 ALL	✓	
[32]	PM GRP2	1.PM GRP2 MODE	✓	
		2.PM GRP2 1/10	✓	
		⋮		
		11.PM GRP2 10/10		
		12.PM GRP2 ALL	✓	
[33]	PM GRP3	1.PM GRP3 MODE	✓	
		2.PM GRP3 1/10	✓	
		⋮		
		11.PM GRP3 10/10		
		12.PM GRP3 ALL	✓	
[34]	PM GRP4	1.PM GRP4 MODE	✓	
		2.PM GRP4 1/10	✓	
		⋮		
		11.PM GRP4 10/10		
		12.PM GRP4 ALL	✓	
[35]	USER BUTTON	1.USER1 ⋮ 8.USER8	✓	<b>(Réglage [FAN])</b> Peut être commuté entre "Auto" et "High".
[36]	CTRL TYPE	1.CAM1 ⋮ 100.CAM100	✓	
[37]	AUTO IP	1.AUTO SET	✓	
[38]	SWAP IP	1.CAM1 ⋮ 100.CAM100	✓	
[39]	MANU IP	1.CAM1 ⋮ 100.CAM100	✓	
[40]	PORT NO	1.CAM1 ⋮ 100.CAM100	✓	
[41]	SW SETUP	1.SW CTL	✓	
		2.SW IP ADDRESS	✓	

✓: Activé ×: Désactivé △: Activé sous conditions

Bouton de numéro	Nom de menu	Élément de réglage	Compatible	Remarques
[42]	SW FUNCTION	1.SW LINK	✓	
		2.SW TYPE	✓	
		3.BUSCONT	✓	
		4.BUS	✓	
		5.FOUCS ASIST	✓	
		6.MV OUTBUS	✓	
		7.CAMERA SELECT	✓	
		8.TALLY_IP	✓	
		9.P/T/Z CONTROL	✓	
		10.CAMINF	✓	
		11.CAMINF_FORMAT	✓	
		12.CAMINF_CNAME	✓	
		13.CAMINF_SCENE	✓	
		14.CAMINF_GAIN	✓	
		15.CAMINF_SHUTER	✓	
		16.CAMINF_IRIS	✓	
		17.CAMINF_FILTER	✓	
		18.CAMINF_ALARM	✓	
[43]	SW INPUT	1.INPUT1 : 100.INPUT100	✓	
[44]	TALLY	1.TALLY IN1 : 10.TALLY IN10	✓	
[45]	GPI OUT	1.CAM OUT1 : 10.CAM OUT10	✓	
[46]	SAVE	SAVE MODE	✓	
[47]	LOAD	LOAD MODE	✓	
[48]	DELETE	DEL MODE	✓	
[49]	SYSTEM	1.INITIALIZE	✓	
		2.SYSTEM VER	✓	
		3.PROGRAM VER	✓	
		4.FPGA VER	✓	
[50]	ALARM	1.POWER	✓	
		2.CAM*** : 11.CAM***	✓	“***” est le numéro de la caméra du groupe sélectionné.

# Elenco delle funzioni compatibili

Quando l'unità viene utilizzata insieme a una camera integrata 4K serie AW-UE150, alcune funzioni saranno limitate o disattivate per alcuni dei pulsanti, dei selettori e altri controlli dell'unità. Fare riferimento alla tabella che segue.

**NOTA**

Per eseguire operazioni, aggiornare l'unità alla versione di sistema 4.00.01 o successive.

**Voci di impostazione (selettori e pulsanti dedicati)**

**Sezione di regolazione colore**

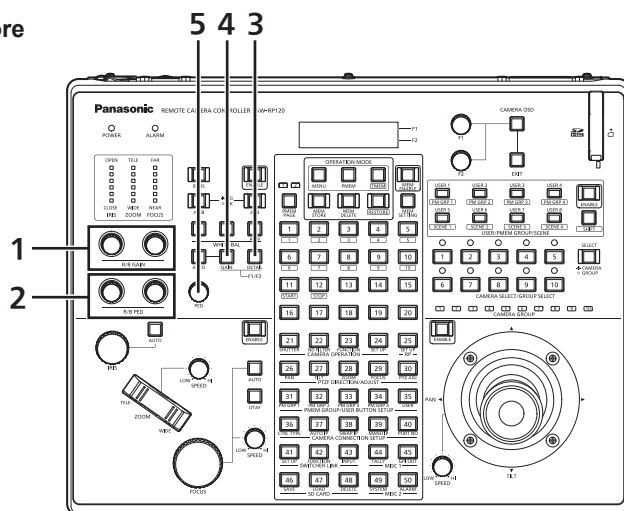

✓: Abilitato ×: Disabilitato △: Abilitato condizionalmente

Numero	Ghiera/pulsante	Compatibile	Note
1	R/B GAIN	✓	
2	R/B PED	✓	
3	DETAIL	✓	
4	GAIN	✓	
5	PED	✓	

**Sezione di selezione menu e memoria**

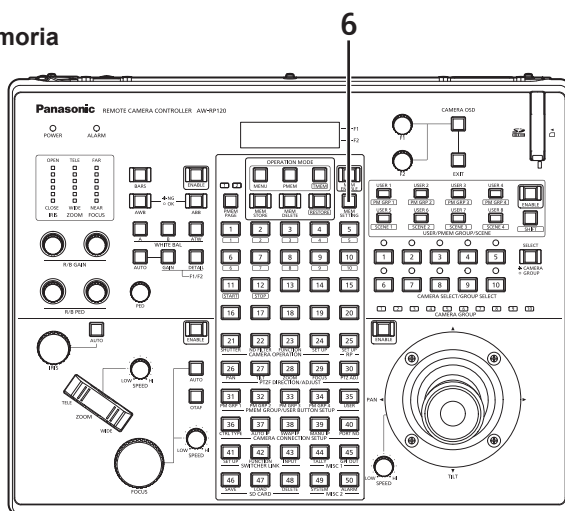

✓: Abilitato ×: Disabilitato △: Abilitato condizionalmente

Numero	Ghiera/pulsante	Compatibile	Note
6	MEM SETTING	△	Quando la [Preset Speed Unit] della videocamera remota è "Time", viene visualizzato "---" e non è disponibile l'impostazione. Tali specifiche non possono essere eseguite dall'unità.

Voci di impostazione (menu)

Sezione di selezione menu e memoria

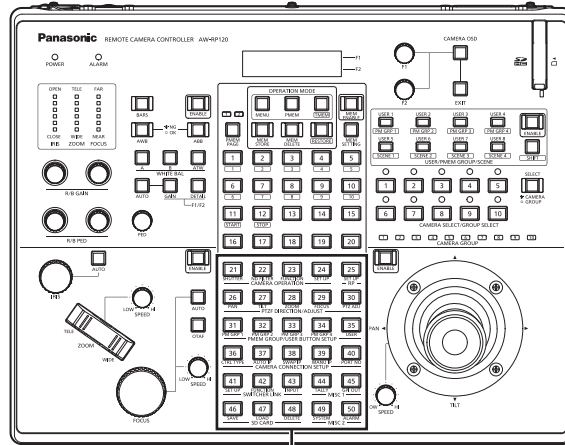

Pulsanti numerici da [21] a [50]

✓: Abilitato ×: Disabilitato △: Abilitato condizionalmente

Pulsante numerico	Nome menu	Voce di impostazione	Compatibile	Note
[21]	SHUTTER	1.SHUTTER	✓	
		2.SPEED	✓	
[22]	ND FILTER	1.ND FILTER	✓	
[23]	FUNCTION	1.OPTION	✓	
		2.DEFROSTER	×	
		3.WIPER	×	
		4.HEATER/FAN	×	
		5.LAMP	×	
		6.PRESET SPEED	✓	
		7.FREEZE DURING	✓	
		8.I.S.	✓	
		9.D.EXTENDER	△	È possibile impostare solo ON o OFF.
		10.CROP OUT SEL	✓	
		11.CROP ADJ SEL	✓	
		12.CROP P/T LVR	✓	
		13.WASHR	×	
		14.FAN	✓	
		15.D.HAZE CLR SW	×	
		16.D.HAZE CLR LV	×	
		17.D-EXTENDER	✓	
		18.ZOOM MODE	✓	
		19.SHOOTING MD	✓	
		20.DRS	✓	
		21.REC	×	
[24]	CAMERA SETUP	1.CAM POWER	✓	
		2.AUTO ON	✓	
		3.RECALL PST SPD	✓	

✓: Abilitato ×: Disabilitato △: Abilitato condizionalmente

Pulsante numerico	Nome menu	Voce di impostazione	Compatibile	Note
[24]	CAMERA SETUP	4.TALLY OUT	✓	
		5.COLOR TEMP	✓	
		6.HOME POSITION	✓	
		7.GAIN SW	✓	
		8.ATW SW	✓	
[25]	RP SETUP	1.FOUCS/IRIS	✓	
		2.P/T CURV	✓	
		3.LCD BACKLIGHT	✓	
		4.ENABLE BUTTON	✓	
		5.MENU CONTROL	✓	
		6.GLOBAL AREA	✓	
		7.IP ADDRESS	✓	
		8.SUBNET MASK	✓	
		9.GATEWAY	✓	
		10.MAC ADDRESS	✓	
		11.PORT CAM1 :	✓	
		20.PORT CAM10		
		21.PANEL LOCK PW	✓	
		22.PANEL LOCK CNT	✓	
		23.TR CTRL	✓	
24.TR IP ADDRESS	✓			
25.TR PORT	✓			
[26]	PAN DIRECTION	1.CAM1 : 100.CAM100	✓	
[27]	TILT DIRECTION	1.CAM1 : 100.CAM100	✓	
[28]	ZOOM DIRECTION	1.CAM1 : 100.CAM100	✓	
[29]	FOCUS DIRECTION	1.CAM1 : 100.CAM100	✓	
[30]	PTZ ADJUST	1.Z MIN SPEED	✓	
		2.SPEED WITH Z	✓	
		3.LIMIT UP	✓	
		4.LIMIT DOWN	✓	
		5.LIMIT LEFT	✓	
		6.LIMIT RIGHT	✓	
		7.AWB/ABB & P/T	✓	
[31]	PM GRP1	1.PM GRP1 MODE	✓	
		2.PM GRP1 1/10 :	✓	
		11.PM GRP1 10/10		
		12.PM GRP1 ALL	✓	

✓: Abilitato ✗: Disabilitato △: Abilitato condizionalmente

Pulsante numerico	Nome menu	Voce di impostazione	Compatibile	Note
[32]	PM GRP2	1.PM GRP2 MODE	✓	
		2.PM GRP2 1/10	✓	
		⋮		
		11.PM GRP2 10/10		
[33]	PM GRP3	12.PM GRP2 ALL	✓	
		1.PM GRP3 MODE	✓	
		2.PM GRP3 1/10	✓	
		⋮		
[34]	PM GRP4	11.PM GRP2 10/10		
		12.PM GRP3 ALL	✓	
		1.PM GRP4 MODE	✓	
		2.PM GRP4 1/10	✓	
[35]	USER BUTTON	⋮		
		8.USER8	✓	<b>(Impostazione [FAN])</b> Può essere commutato tra "Auto" e "High".
		1.USER1		
		⋮		
[36]	CTRL TYPE	1.CAM1	✓	
		⋮		
		100.CAM100		
[37]	AUTO IP	1.AUTO SET	✓	
[38]	SWAP IP	1.CAM1	✓	
		⋮		
		100.CAM100		
[39]	MANU IP	1.CAM1	✓	
		⋮		
		100.CAM100		
[40]	PORT NO	1.CAM1	✓	
		⋮		
		100.CAM100		
[41]	SW SETUP	1.SW CTL	✓	
		2.SW IP ADDRESS	✓	
[42]	SW FUNCTION	1.SW LINK	✓	
		2.SW TYPE	✓	
		3.BUSCONT	✓	
		4.BUS	✓	
		5.FOUCS ASIST	✓	
		6.MV OUTBUS	✓	
		7.CAMERA SELECT	✓	
		8.TALLY_IP	✓	
		9.P/T/Z CONTROL	✓	
		10.CAMINF	✓	
		11.CAMINF_FORMAT	✓	
		12.CAMINF_CNAME	✓	
		13.CAMINF_SCENE	✓	
		14.CAMINF_GAIN	✓	
		15.CAMINF_SHUTER	✓	
				16.CAMINF_IRIS



✓: Abilitato ✗: Disabilitato △: Abilitato condizionalmente

Pulsante numerico	Nome menu	Voce di impostazione	Compatibile	Note
[42]	SW FUNCTION	17.CAMINF_FILTER	✓	
		18.CAMINF_ALARM	✓	
[43]	SW INPUT	1.INPUT1 : 100.INPUT100	✓	
[44]	TALLY	1.TALLY IN1 : 10.TALLY IN10	✓	
[45]	GPI OUT	1.CAM OUT1 : 10.CAM OUT10	✓	
[46]	SAVE	SAVE MODE	✓	
[47]	LOAD	LOAD MODE	✓	
[48]	DELETE	DEL MODE	✓	
[49]	SYSTEM	1.INITIALIZE	✓	
		2.SYSTEM VER	✓	
		3.PROGRAM VER	✓	
		4.FPGA VER	✓	
[50]	ALARM	1.POWER	✓	
		2.CAM*** : 11.CAM***	✓	“***” è il numero di videocamera del gruppo selezionato.

# Lista de funciones compatibles

Cuando se utilice la unidad con una cámara integrada 4K de la serie AW-UE150, habrá funciones que estén limitadas o deshabilitadas para algunos de los botones, diales y otras funciones de control de la unidad. Consulte la tabla que viene a continuación.

**NOTA**

Para realizar las operaciones, actualice la versión del sistema de la unidad a la 4.00.01 o posterior.

**Elementos de ajuste (botones y diales específicos)**

**Sección de ajuste de color**

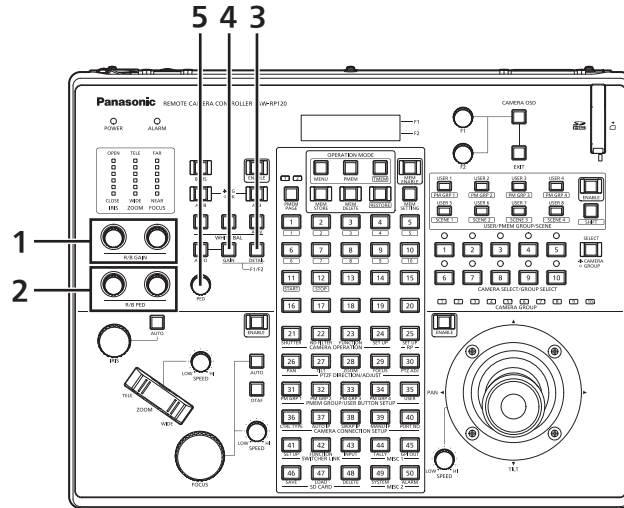

✓: Activado ×: Desactivado △: Activado según el caso

Número	Dial/botón	Compatible	Notas
1	R/B GAIN	✓	
2	R/B PED	✓	
3	DETAIL	✓	
4	GAIN	✓	
5	PED	✓	

**Sección de selección de memoria y menú**

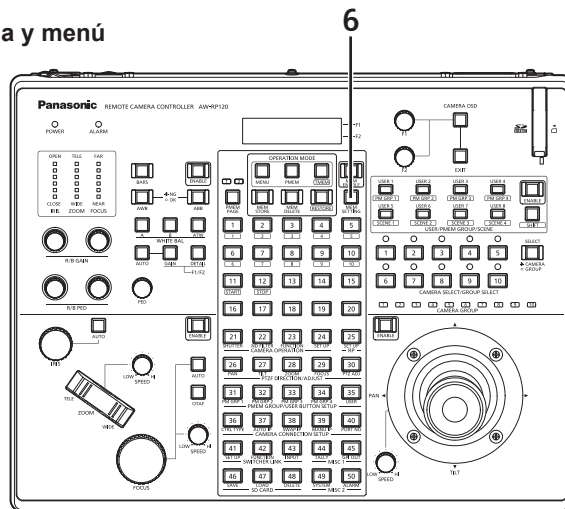

✓: Activado ×: Desactivado △: Activado según el caso

Número	Dial/botón	Compatible	Notas
6	MEM SETTING	△	Cuando [Preset Speed Unit] de la cámara remota es "Time", se visualiza "---" y el ajuste no es posible. La especificación de hora no puede realizarse desde la unidad.

Elementos de ajuste (menús)

Sección de selección de memoria y menú

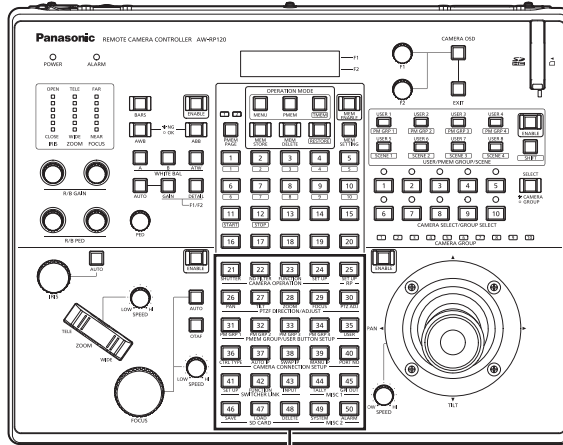

Botones numéricos [21] a [50]

✓: Activado X: Desactivado △: Activado según el caso

Botón numérico	Nombre de menú	Elemento de ajuste	Compatible	Notas
[21]	SHUTTER	1.SHUTTER	✓	
		2.SPEED	✓	
[22]	ND FILTER	1.ND FILTER	✓	
[23]	FUNCTION	1.OPTION	✓	
		2.DEFROSTER	X	
		3.WIPER	X	
		4.HEATER/FAN	X	
		5.LAMP	X	
		6.PRESET SPEED	✓	
		7.FREEZE DURING	✓	
		8.I.S.	✓	
		9.D.EXTENDER	△	Solamente pueden ajustarse ON u OFF.
		10.CROP OUT SEL	✓	
		11.CROP ADJ SEL	✓	
		12.CROP P/T LVR	✓	
		13.WASHR	X	
		14.FAN	✓	
		15.D.HAZE CLR SW	X	
		16.D.HAZE CLR LV	X	
		17.D-EXTENDER	✓	
		18.ZOOM MODE	✓	
		19.SHOOTING MD	✓	
		20.DRS	✓	
		21.REC	X	

✓: Activado ×: Desactivado △: Activado según el caso

Botón numérico	Nombre de menú	Elemento de ajuste	Compatible	Notas
[24]	CAMERA SETUP	1.CAM POWER	✓	
		2.AUTO ON	✓	
		3.RECALL PST SPD	✓	
		4.TALLY OUT	✓	
		5.COLOR TEMP	✓	
		6.HOME POSITION	✓	
		7.GAIN SW	✓	
		8.ATW SW	✓	
[25]	RP SETUP	1.FOUCS/IRIS	✓	
		2.P/T CURV	✓	
		3.LCD BACKLIGHT	✓	
		4.ENABLE BUTTON	✓	
		5.MENU CONTROL	✓	
		6.GLOBAL AREA	✓	
		7.IP ADDRESS	✓	
		8.SUBNET MASK	✓	
		9.GATEWAY	✓	
		10.MAC ADDRESS	✓	
		11.PORT CAM1 :	✓	
		20.PORT CAM10		
		21.PANEL LOCK PW	✓	
		22.PANEL LOCK CNT	✓	
		23.TR CTRL	✓	
24.TR IP ADDRESS	✓			
25.TR PORT	✓			
[26]	PAN DIRECTION	1.CAM1 : 100.CAM100	✓	
[27]	TILT DIRECTION	1.CAM1 : 100.CAM100	✓	
[28]	ZOOM DIRECTION	1.CAM1 : 100.CAM100	✓	
[29]	FOCUS DIRECTION	1.CAM1 : 100.CAM100	✓	
[30]	PTZ ADJUST	1.Z MIN SPEED	✓	
		2.SPEED WITH Z	✓	
		3.LIMIT UP	✓	
		4.LIMIT DOWN	✓	
		5.LIMIT LEFT	✓	
		6.LIMIT RIGHT	✓	
		7.AWB/ABB & P/T	✓	

✓: Activado ×: Desactivado △: Activado según el caso

Botón numérico	Nombre de menú	Elemento de ajuste	Compatible	Notas
[31]	PM GRP1	1.PM GRP1 MODE	✓	
		2.PM GRP1 1/10	✓	
		⋮		
		11.PM GRP1 10/10		
		12.PM GRP1 ALL	✓	
[32]	PM GRP2	1.PM GRP2 MODE	✓	
		2.PM GRP2 1/10	✓	
		⋮		
		11.PM GRP2 10/10		
		12.PM GRP2 ALL	✓	
[33]	PM GRP3	1.PM GRP3 MODE	✓	
		2.PM GRP3 1/10	✓	
		⋮		
		11.PM GRP3 10/10		
		12.PM GRP3 ALL	✓	
[34]	PM GRP4	1.PM GRP4 MODE	✓	
		2.PM GRP4 1/10	✓	
		⋮		
		11.PM GRP4 10/10		
		12.PM GRP4 ALL	✓	
[35]	USER BUTTON	1.USER1 ⋮ 8.USER8	✓	<b>(Ajuste [FAN])</b> Puede cambiarse entre "Auto" y "High".
[36]	CTRL TYPE	1.CAM1 ⋮ 100.CAM100	✓	
[37]	AUTO IP	1.AUTO SET	✓	
[38]	SWAP IP	1.CAM1 ⋮ 100.CAM100	✓	
[39]	MANU IP	1.CAM1 ⋮ 100.CAM100	✓	
[40]	PORT NO	1.CAM1 ⋮ 100.CAM100	✓	
[41]	SW SETUP	1.SW CTL	✓	
		2.SW IP ADDRESS	✓	

✓: Activado ×: Desactivado △: Activado según el caso

Botón numérico	Nombre de menú	Elemento de ajuste	Compatible	Notas
[42]	SW FUNCTION	1.SW LINK	✓	
		2.SW TYPE	✓	
		3.BUSCONT	✓	
		4.BUS	✓	
		5.FOUCS ASIST	✓	
		6.MV OUTBUS	✓	
		7.CAMERA SELECT	✓	
		8.TALLY_IP	✓	
		9.P/T/Z CONTROL	✓	
		10.CAMINF	✓	
		11.CAMINF_FORMAT	✓	
		12.CAMINF_CNAME	✓	
		13.CAMINF_SCENE	✓	
		14.CAMINF_GAIN	✓	
		15.CAMINF_SHUTER	✓	
		16.CAMINF_IRIS	✓	
		17.CAMINF_FILTER	✓	
		18.CAMINF_ALARM	✓	
[43]	SW INPUT	1.INPUT1 : 100.INPUT100	✓	
[44]	TALLY	1.TALLY IN1 : 10.TALLY IN10	✓	
[45]	GPI OUT	1.CAM OUT1 : 10.CAM OUT10	✓	
[46]	SAVE	SAVE MODE	✓	
[47]	LOAD	LOAD MODE	✓	
[48]	DELETE	DEL MODE	✓	
[49]	SYSTEM	1.INITIALIZE	✓	
		2.SYSTEM VER	✓	
		3.PROGRAM VER	✓	
		4.FPGA VER	✓	
[50]	ALARM	1.POWER	✓	
		2.CAM*** : 11.CAM***	✓	“***” es el número de la cámara del grupo seleccionado.

# Перечень совместимых функций

Когда устройство используется в сочетании с интегрированной камерой 4K серии AW-UE150, некоторые функции для ряда кнопок, вращающихся ручек и других органов управления устройства будут ограничены в использовании или отключены. Обязательно обратитесь к следующей таблице.

**Примечание**

Для выполнения операций обновите версию системы устройства до 4.00.01 или выше.

**Пункты установок (вращающиеся ручки и кнопки со специальными функциями)**

**Раздел настроек цвета**

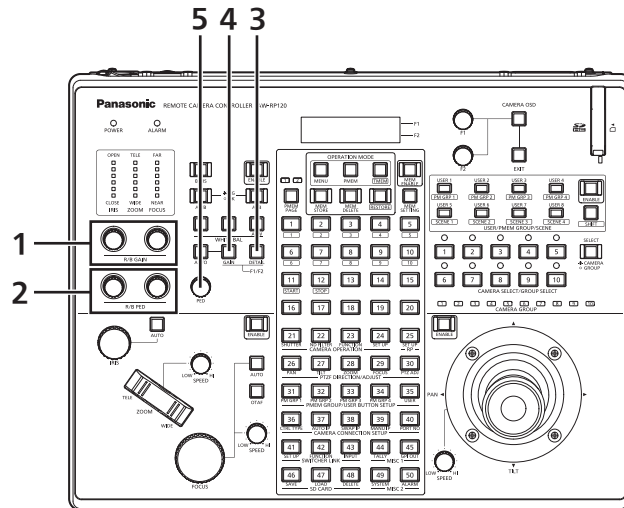

✓: Включено X: Отключено △: Включено с дополнительными условиями

Номер	Вращающаяся ручка/кнопка	Совместимость	Примечания
1	R/B GAIN	✓	
2	R/B PED	✓	
3	DETAIL	✓	
4	GAIN	✓	
5	PED	✓	

**Раздел выбора меню и памяти**

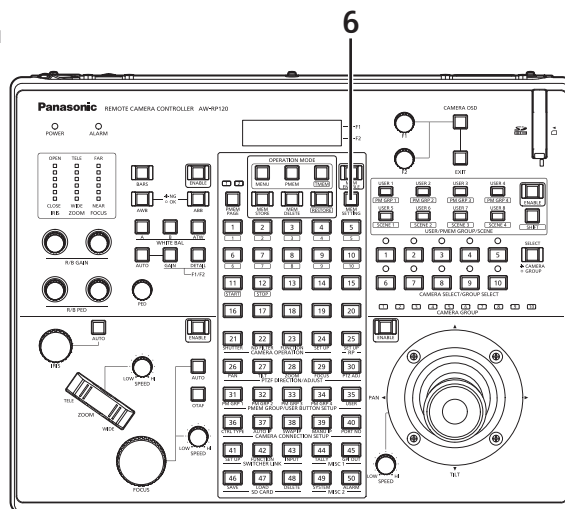

✓: Включено X: Отключено △: Включено с дополнительными условиями

Номер	Вращающаяся ручка/кнопка	Совместимость	Примечания
6	MEM SETTING	△	Когда для опции [Preset Speed Unit] удаленной камеры выбрана установка "Time", то отображается "---", и установка невозможна. С данного устройства нельзя выполнить установку временных характеристик.

Пункты установок (меню)

Раздел выбора меню и памяти

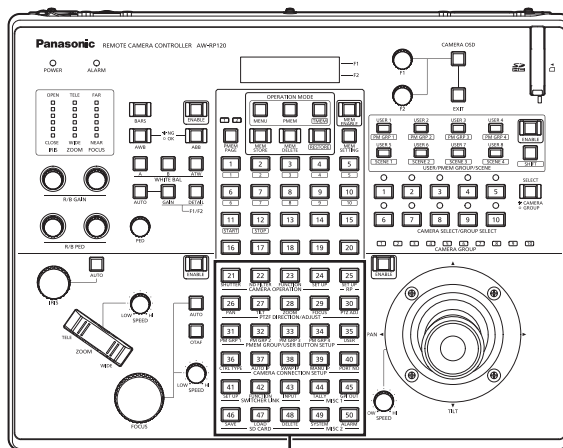

Числовые кнопки с [21] по [50]

✓: Включено X: Отключено Δ: Включено с дополнительными условиями

Числовая кнопка	Название меню	Пункт установки	Совместимость	Примечания
[21]	SHUTTER	1.SHUTTER	✓	
		2.SPEED	✓	
[22]	ND FILTER	1.ND FILTER	✓	
[23]	FUNCTION	1.OPTION	✓	
		2.DEFROSTER	X	
		3.WIPER	X	
		4.HEATER/FAN	X	
		5.LAMP	X	
		6.PRESET SPEED	✓	
		7.FREEZE DURING	✓	
		8.I.S.	✓	
		9.D.EXTENDER	Δ	Можно установить только ON или OFF.
		10.CROP OUT SEL	✓	
		11.CROP ADJ SEL	✓	
		12.CROP P/T LVR	✓	
		13.WASHR	X	
		14.FAN	✓	
		15.D.HAZE CLR SW	X	
		16.D.HAZE CLR LV	X	
		17.D-EXTENDER	✓	
		18.ZOOM MODE	✓	
		19.SHOOTING MD	✓	
		20.DRS	✓	
		21.REC	X	



✓: Включено X: Отключено △: Включено с дополнительными условиями

Числовая кнопка	Название меню	Пункт установки	Совместимость	Примечания
[24]	CAMERA SETUP	1.CAM POWER	✓	
		2.AUTO ON	✓	
		3.RECALL PST SPD	✓	
		4.TALLY OUT	✓	
		5.COLOR TEMP	✓	
		6.HOME POSITION	✓	
		7.GAIN SW	✓	
		8.ATW SW	✓	
[25]	RP SETUP	1.FOUCS/IRIS	✓	
		2.P/T CURV	✓	
		3.LCD BACKLIGHT	✓	
		4.ENABLE BUTTON	✓	
		5.MENU CONTROL	✓	
		6.GLOBAL AREA	✓	
		7.IP ADDRESS	✓	
		8.SUBNET MASK	✓	
		9.GATEWAY	✓	
		10.MAC ADDRESS	✓	
		11.PORT CAM1 :	✓	
		20.PORT CAM10		
		21.PANEL LOCK PW	✓	
		22.PANEL LOCK CNT	✓	
		23.TR CTRL	✓	
24.TR IP ADDRESS	✓			
25.TR PORT	✓			
[26]	PAN DIRECTION	1.CAM1 : 100.CAM100	✓	
[27]	TILT DIRECTION	1.CAM1 : 100.CAM100	✓	
[28]	ZOOM DIRECTION	1.CAM1 : 100.CAM100	✓	
[29]	FOCUS DIRECTION	1.CAM1 : 100.CAM100	✓	
[30]	PTZ ADJUST	1.Z MIN SPEED	✓	
		2.SPEED WITH Z	✓	
		3.LIMIT UP	✓	
		4.LIMIT DOWN	✓	
		5.LIMIT LEFT	✓	
		6.LIMIT RIGHT	✓	
		7.AWB/ABB & P/T	✓	

✓: Включено X: Отключено △: Включено с дополнительными условиями

Числовая кнопка	Название меню	Пункт установки	Совместимость	Примечания
[31]	PM GRP1	1.PM GRP1 MODE	✓	
		2.PM GRP1 1/10	✓	
		⋮		
		11.PM GRP1 10/10		
[32]	PM GRP2	12.PM GRP1 ALL	✓	
		1.PM GRP2 MODE	✓	
		2.PM GRP2 1/10	✓	
		⋮		
[33]	PM GRP3	11.PM GRP2 10/10		
		12.PM GRP2 ALL	✓	
		1.PM GRP3 MODE	✓	
		2.PM GRP3 1/10	✓	
[34]	PM GRP4	⋮		
		11.PM GRP3 10/10		
		12.PM GRP3 ALL	✓	
		1.PM GRP4 MODE	✓	
[35]	USER BUTTON	2.PM GRP4 1/10	✓	
		⋮		
		11.PM GRP4 10/10		
		12.PM GRP4 ALL	✓	
[36]	CTRL TYPE	1.USER1	✓	<b>(Установка [FAN])</b> Может переключаться между "Auto" и "High".
		⋮		
		8.USER8		
[37]	AUTO IP	1.CAM1	✓	
		⋮		
		100.CAM100		
[38]	SWAP IP	1.AUTO SET	✓	
		1.CAM1	✓	
		⋮		
		100.CAM100		
[39]	MANU IP	1.CAM1	✓	
		⋮		
		100.CAM100		
[40]	PORT NO	1.CAM1	✓	
		⋮		
		100.CAM100		
[41]	SW SETUP	1.SW CTL	✓	
		2.SW IP ADDRESS	✓	

✓: Включено X: Отключено △: Включено с дополнительными условиями

Числовая кнопка	Название меню	Пункт установки	Совместимость	Примечания
[42]	SW FUNCTION	1.SW LINK	✓	
		2.SW TYPE	✓	
		3.BUSCONT	✓	
		4.BUS	✓	
		5.FOUCS ASIST	✓	
		6.MV OUTBUS	✓	
		7.CAMERA SELECT	✓	
		8.TALLY_IP	✓	
		9.P/T/Z CONTROL	✓	
		10.CAMINF	✓	
		11.CAMINF_FORMAT	✓	
		12.CAMINF_CNAME	✓	
		13.CAMINF_SCENE	✓	
		14.CAMINF_GAIN	✓	
		15.CAMINF_SHUTER	✓	
		16.CAMINF_IRIS	✓	
		17.CAMINF_FILTER	✓	
		18.CAMINF_ALARM	✓	
[43]	SW INPUT	1.INPUT1 : 100.INPUT100	✓	
[44]	TALLY	1.TALLY IN1 : 10.TALLY IN10	✓	
[45]	GPI OUT	1.CAM OUT1 : 10.CAM OUT10	✓	
[46]	SAVE	SAVE MODE	✓	
[47]	LOAD	LOAD MODE	✓	
[48]	DELETE	DEL MODE	✓	
[49]	SYSTEM	1.INITIALIZE	✓	
		2.SYSTEM VER	✓	
		3.PROGRAM VER	✓	
		4.FPGA VER	✓	
[50]	ALARM	1.POWER	✓	
		2.CAM*** : 11.CAM***	✓	“***” – номер камеры выбранной группы.

# 対応機能一覧

本機を 4K インテグレートドカメラ AW-UE150 シリーズと接続してご使用になる場合、本機の一部のボタンやダイヤルなどの機能が制限されたり、無効になったりします。下表をもとに、ご確認ください。

## NOTE

操作を行うには、本機のシステムのバージョンを 4.00.01 以降にアップグレードしてください。

### 設定項目 (専用ダイヤル、ボタン)

#### カラーアジャスト部

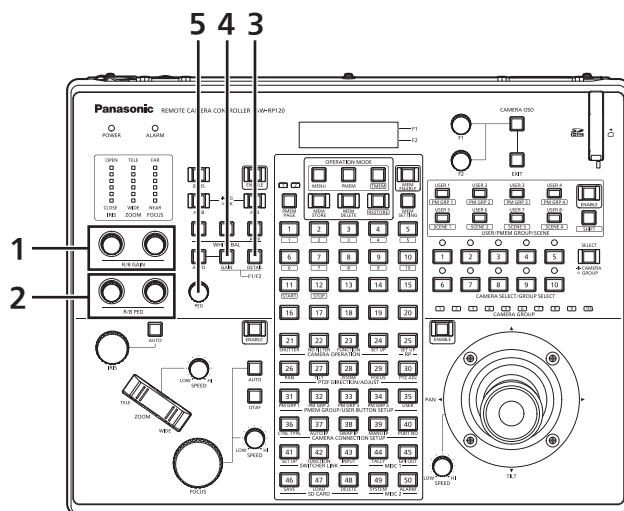

○: 有効 ×: 無効 △: 条件付きで有効

番号	ダイヤル、ボタン	対応	備考
1	R/B GAIN	○	
2	R/B PED	○	
3	DETAIL	○	
4	GAIN	○	
5	PED	○	

#### メニュー、メモリー選択部

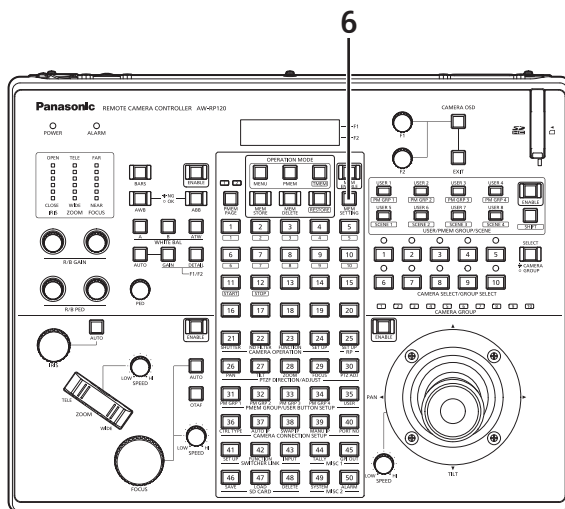

○: 有効 ×: 無効 △: 条件付きで有効

番号	ダイヤル、ボタン	対応	備考
6	MEM SETTING	△	リモートカメラの [Preset Speed Unit] が「Time」のときは「---」と表示され、設定することができません。本機から時間指定は行なえません。

設定項目 (メニュー)

メニュー、メモリー選択部

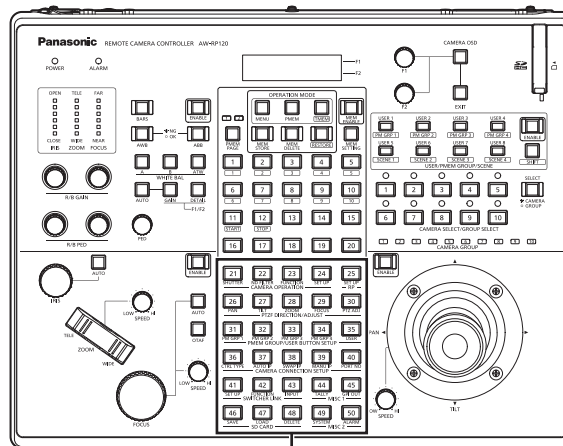

数字ボタン [21] ~ [50]

○: 有効 ×: 無効 △: 条件付きで有効

数字ボタン	メニュー名称	設定項目	対応	備考
[21]	SHUTTER	1.SHUTTER	○	
		2.SPEED	○	
[22]	ND FILTER	1.ND FILTER	○	
[23]	FUNCTION	1.OPTION	○	
		2.DEFROSTER	×	
		3.WIPER	×	
		4.HEATER/FAN	×	
		5.LAMP	×	
		6.PRESET SPEED	○	
		7.FREEZE DURING	○	
		8.I.S.	○	
		9.D.EXTENDER	△	ON/OFFのみ設定できます。
		10.CROP OUT SEL	○	
		11.CROP ADJ SEL	○	
		12.CROP P/T LVR	○	
		13.WASHR	×	
		14.FAN	○	
		15.D.HAZE CLR SW	×	
		16.D.HAZE CLR LV	×	
		17.D-EXTENDER	○	
		18.ZOOM MODE	○	
		19.SHOOTING MD	○	
		20.DRS	○	
		21.REC	×	
[24]	CAMERA SETUP	1.CAM POWER	○	
		2.AUTO ON	○	
		3.RECALL PST SPD	○	

○: 有効 ×: 無効 △: 条件付きで有効

数字ボタン	メニュー名称	設定項目	対応	備考
[24]	CAMERA SETUP	4.TALLY OUT	○	
		5.COLOR TEMP	○	
		6.HOME POSITION	○	
		7.GAIN SW	○	
		8.ATW SW	○	
[25]	RP SETUP	1.FOUCS/IRIS	○	
		2.P/T CURV	○	
		3.LCD BACKLIGHT	○	
		4.ENABLE BUTTON	○	
		5.MENU CONTROL	○	
		6.GLOBAL AREA	○	
		7.IP ADDRESS	○	
		8.SUBNET MASK	○	
		9.GATEWAY	○	
		10.MAC ADDRESS	○	
		11.PORT CAM1 :	○	
		20.PORT CAM10		
		21.PANEL LOCK PW	○	
		22.PANEL LOCK CNT	○	
		23.TR CTRL	○	
24.TR IP ADDRESS	○			
25.TR PORT	○			
[26]	PAN DIRECTION	1.CAM1 : 100.CAM100	○	
[27]	TILT DIRECTION	1.CAM1 : 100.CAM100	○	
[28]	ZOOM DIRECTION	1.CAM1 : 100.CAM100	○	
[29]	FOCUS DIRECTION	1.CAM1 : 100.CAM100	○	
[30]	PTZ ADJUST	1.Z MIN SPEED	○	
		2.SPEED WITH Z	○	
		3.LIMIT UP	○	
		4.LIMIT DOWN	○	
		5.LIMIT LEFT	○	
		6.LIMIT RIGHT	○	
		7.AWB/ABB & P/T	○	
[31]	PM GRP1	1.PM GRP1 MODE	○	
		2.PM GRP1 1/10 :	○	
		11.PM GRP1 10/10		
		12.PM GRP1 ALL	○	

○: 有効 ×: 無効 △: 条件付きで有効

数字ボタン	メニュー名称	設定項目	対応	備考
[32]	PM GRP2	1.PM GRP2 MODE	○	
		2.PM GRP2 1/10	○	
		⋮		
		11.PM GRP2 10/10		
[33]	PM GRP3	12.PM GRP2 ALL	○	
		1.PM GRP3 MODE	○	
		2.PM GRP3 1/10	○	
		⋮		
[34]	PM GRP4	11.PM GRP2 10/10		
		12.PM GRP3 ALL	○	
		1.PM GRP4 MODE	○	
		2.PM GRP4 1/10	○	
[35]	USER BUTTON	⋮		
		8.USER8	○	〔FAN〕の設定 「Auto」と「High」を切り替え できます。
		1.USER1	○	
		⋮		
[36]	CTRL TYPE	1.CAM1	○	
		⋮		
[37]	AUTO IP	100.CAM100		
		1.AUTO SET	○	
[38]	SWAP IP	1.CAM1	○	
		⋮		
[39]	MANU IP	100.CAM100		
		1.CAM1	○	
[40]	PORT NO	⋮		
		100.CAM100	○	
[41]	SW SETUP	1.SW CTL	○	
		2.SW IP ADDRESS	○	
[42]	SW FUNCTION	1.SW LINK	○	
		2.SW TYPE	○	
		3.BUSCONT	○	
		4.BUS	○	
		5.FOUCS ASIST	○	
		6.MV OUTBUS	○	
		7.CAMERA SELECT	○	
		8.TALLY_IP	○	
		9.P/T/Z CONTROL	○	
		10.CAMINF	○	
		11.CAMINF_FORMAT	○	
		12.CAMINF_CNAME	○	
		13.CAMINF_SCENE	○	
		14.CAMINF_GAIN	○	
		15.CAMINF_SHUTER	○	
		16.CAMINF_IRIS	○	

○: 有効 ×: 無効 △: 条件付きで有効

数字ボタン	メニュー名称	設定項目	対応	備考
[42]	SW FUNCTION	17.CAMINF_FILTER	○	
		18.CAMINF_ALARM	○	
[43]	SW INPUT	1.INPUT1 : 100.INPUT100	○	
[44]	TALLY	1.TALLY IN1 : 10.TALLY IN10	○	
[45]	GPI OUT	1.CAM OUT1 : 10.CAM OUT10	○	
[46]	SAVE	SAVE MODE	○	
[47]	LOAD	LOAD MODE	○	
[48]	DELETE	DEL MODE	○	
[49]	SYSTEM	1.INITIALIZE	○	
		2.SYSTEM VER	○	
		3.PROGRAM VER	○	
		4.FPGA VER	○	
[50]	ALARM	1.POWER	○	
		2.CAM*** : 11.CAM***	○	「***」は、選択されているグループのカメラ番号です。